



Torsion Springs are helical springs that exert a torque or rotary force. The ends of torsion springs are attached to other components, and when those components rotate around the center of the spring, the spring tries to push them back to their original position. Although the name implies otherwise, torsion springs are subjected to bending stress rather than torsional stress. They can store and release angular energy or statically hold a mechanism in place by deflecting the legs about the body centerline axis.

This type of spring is normally close wound but can have increased pitch to reduce friction between the coils. They offer resistance to twist or rotationally applied force. Depending on the application, torsion springs can be designed to work in a clockwise or counter-clockwise rotation, thus determining the direction of the wind.

Comprehensive Capabilities

Configurations:

- Straight Offset Legs • Short Hook Legs • Hinge Legs
- Straight Torsion Legs • Bent Legs • Double Torsion

Secondaries:

- Stress Relieve • Heat Treating • Passivation
- Shot Peening • Plating • Painting

Wire sizes from .002" through .625"

Materials:

- Carbon Steels • Alloy Steels
- Stainless Steel 17-7, 302, 304 and 316 • Phosphor Bronze
- Hastelloy • Inconel 600, 718 and x750
- Beryllium Copper • Elgiloy®†

† Elgiloy is a trademark of Elgiloy Ltd. Partnership.

TABLE 1





I  Straight Offset Ends	II  Short Hook Ends	III  Double Torsion
IV  Hinge Ends	V  Straight Torsion Ends	VI  Special Ends

TABLE 2

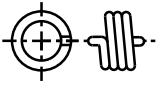
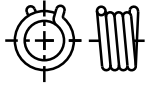

INDICATE UNITS OF MEASURE (IN. & LB.), (MM & KG)

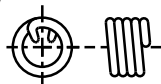
1. MATERIAL _____
2. WIRE DIAMETER _____
3. DIRECTION OF WIND LH RH (SEE TABLE 2)
4. END STYLE Ⓐ I II III IV V VI (SEE
5. END STYLE Ⓑ I II III IV V VI TABLE 1)
6. RATE _____ +/- _____ BETWEEN _____ PER TURN (360°)
7. TORQUE 1 _____ +/- _____ AT \ominus 1 _____ °
8. TORQUE 2 _____ +/- _____ AT \ominus 2 _____ °
9. LENGTH OF SPACE AVAILABLE _____
10. MAXIMUM WOUND POSITION _____ ° FROM FREE POSITION.
11. \ominus F _____ FREE ANGLE OR POSITION
12. FINISH _____
13. FREQUENCY OF ROTATION
_____ CYCLES/SEC. AND
WORKING RANGE \ominus _____ ° TO \ominus _____ ° DEFLECTION
14. OPERATING TEMP. _____ °F
15. OTHER: _____

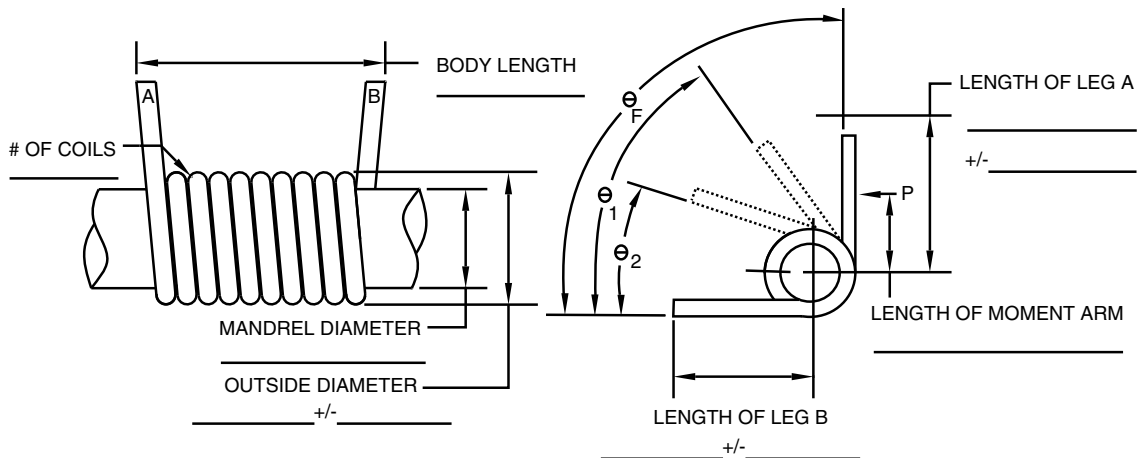
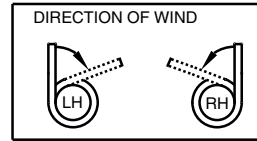
COMPANY: _____

ADDRESS: _____

CITY: _____

STATE: _____ ZIP: _____

CONTACT: _____

PHONE: _____

FAX: _____

EMAIL: _____

QUANTITIES TO BE QUOTED: _____

END USE OR APPLICATION: _____